

Rozměry v mm
 Maße in mm
 Dimensions in mm

Heat R 2g S 50.44.33.13(23)

100kg

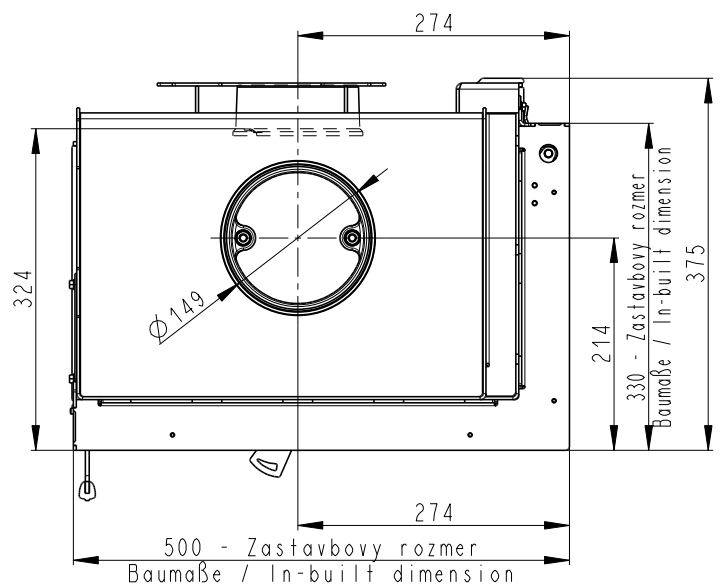
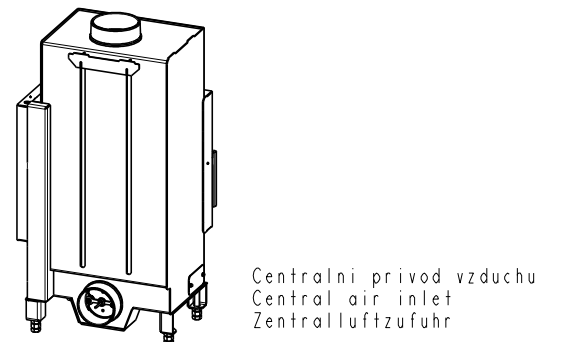
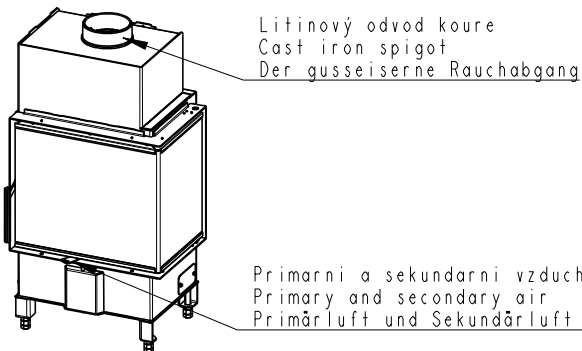
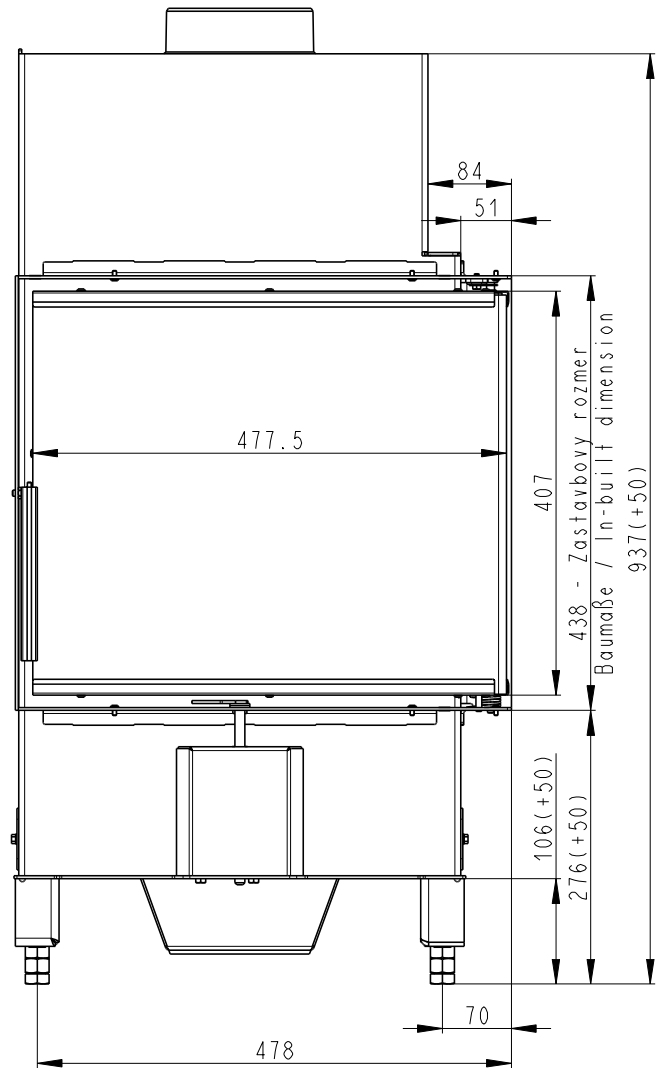
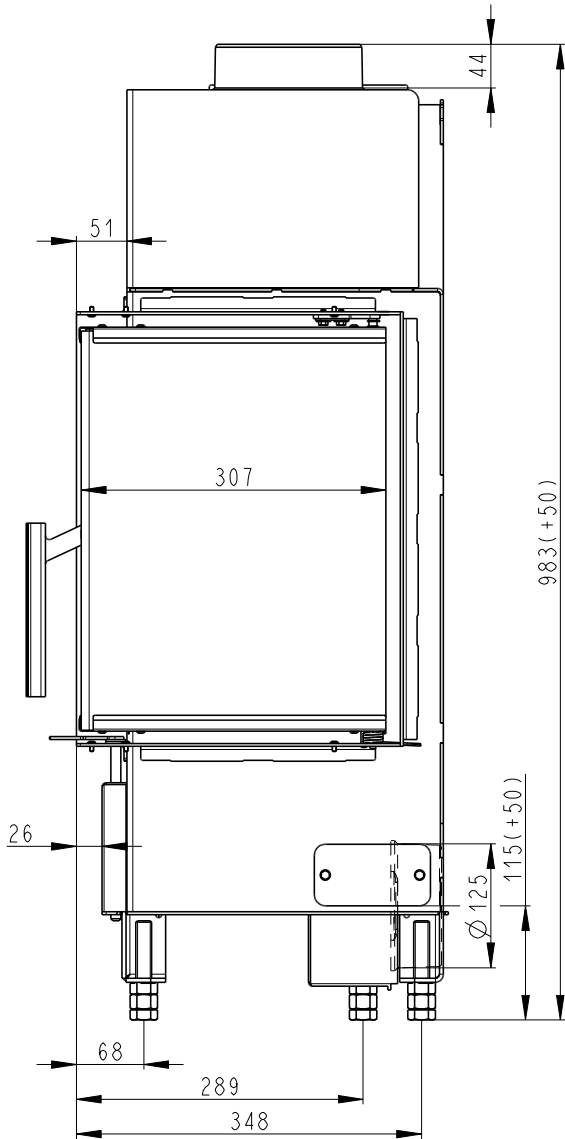

Rozměry v mm
 Maße in mm
 Dimensions in mm

Heat L 2g S 50.44.33.13(23)

100kg

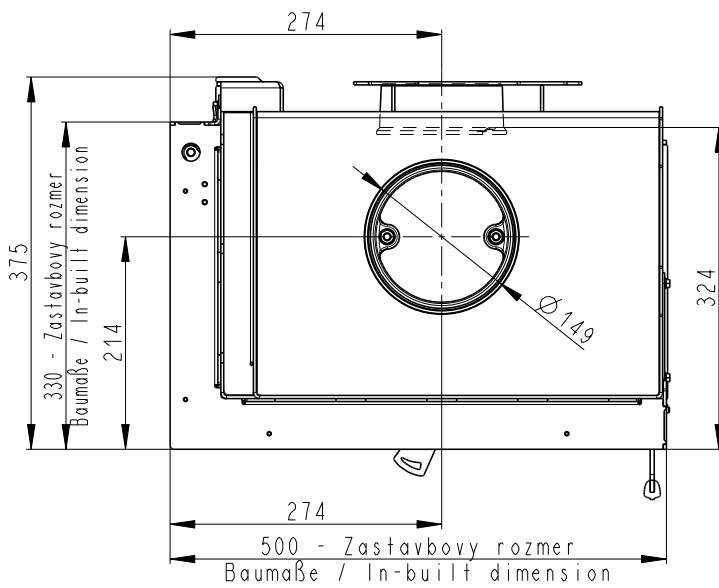
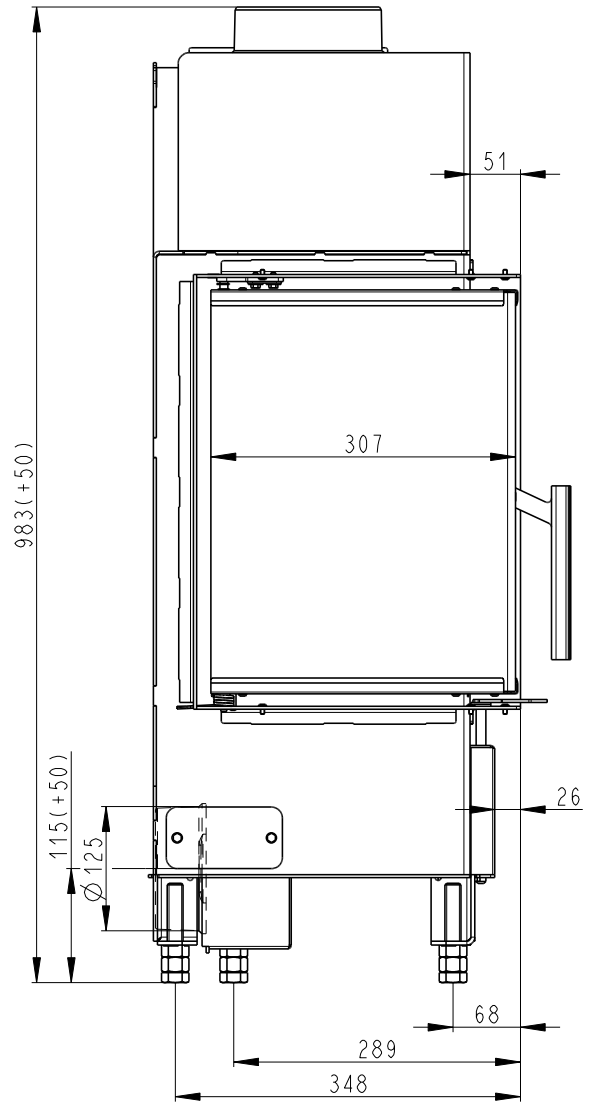
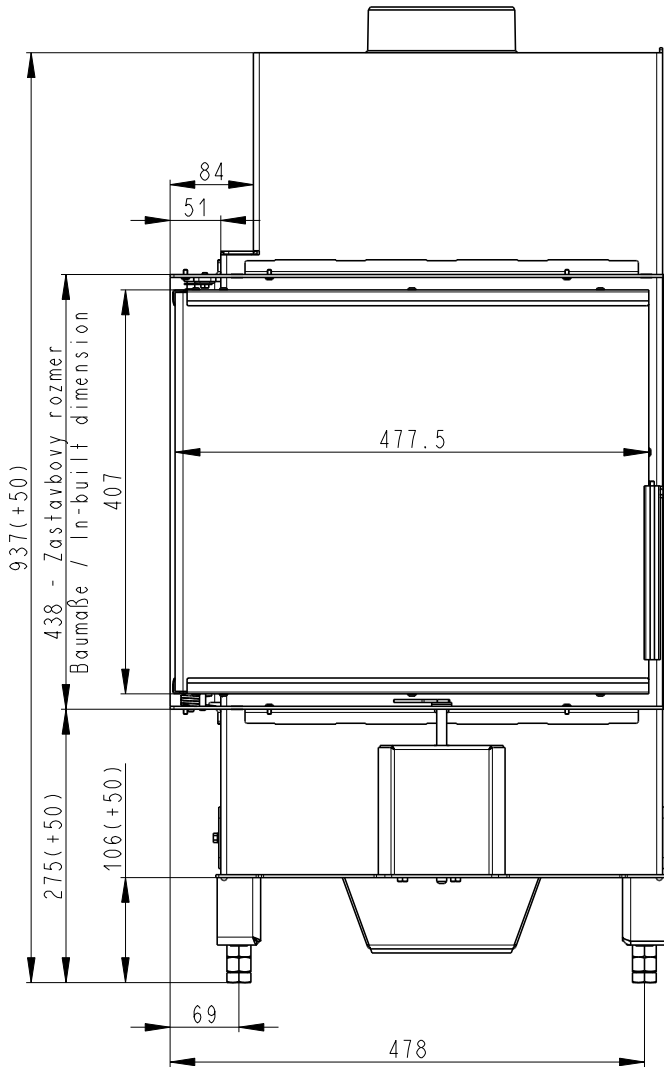

Litínový odvod kouře
 Cast iron spigot
 Der gusseiserne Rauchabgang

Primární a sekundární vzduch
 Primary and secondary air
 Primärluft und Sekundärluft

Centrální přívod vzduchu
 Central air inlet
 Zentralluftzufuhr